

# Orbit server overview

## Setup information

```
INPUT_BPM_UDP  
DIGITAL_FILTER  
MATRIX_MULT  
OUTPUT_ROCS_UDP
```

## Initial parameters

```
FILTER_COEFF=...  
MATRIX=...  
...
```

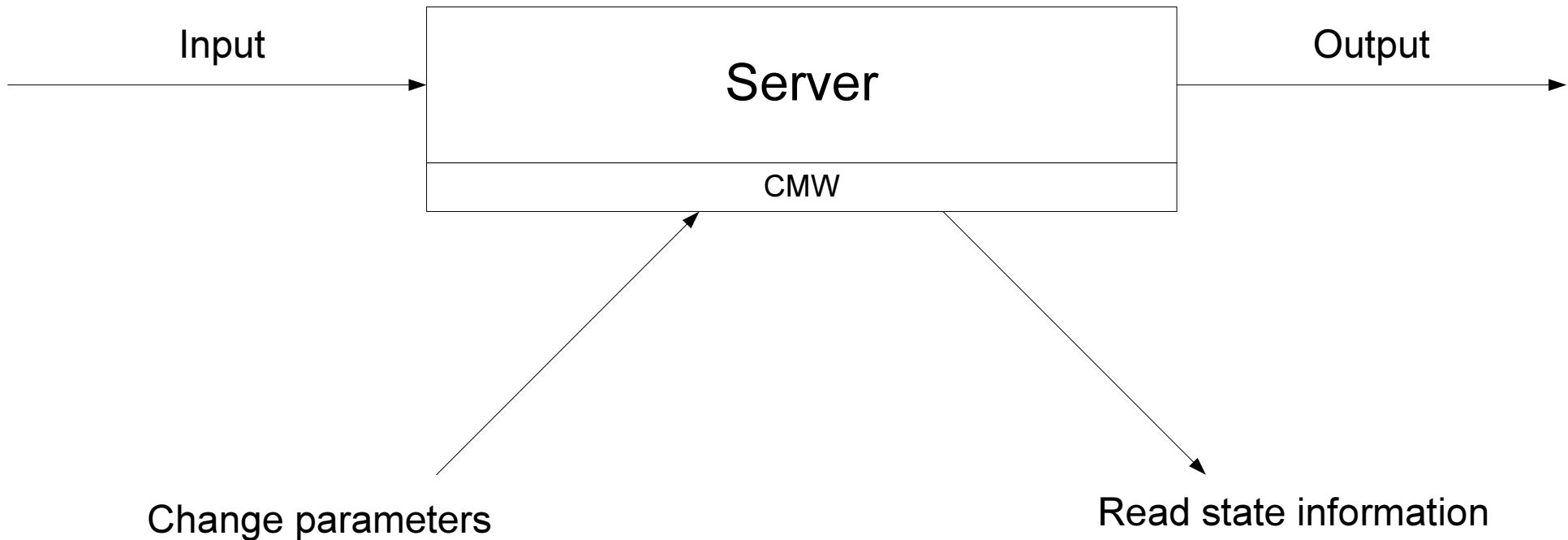

# Current test setup

## PCR

LYNX 4 PPC	TIMING
LYNX 4 PPC	
LYNX 4 PPC	
LYNX 4 PPC	
LYNX 4 PPC	

LYNX 4 PC	TIMING
-----------	--------

## Point 8

LYNX 4 PPC	TIMING
LYNX 4 PPC	
LYNX 4 PPC	
LYNX 4 PPC	
LYNX 4 PPC	

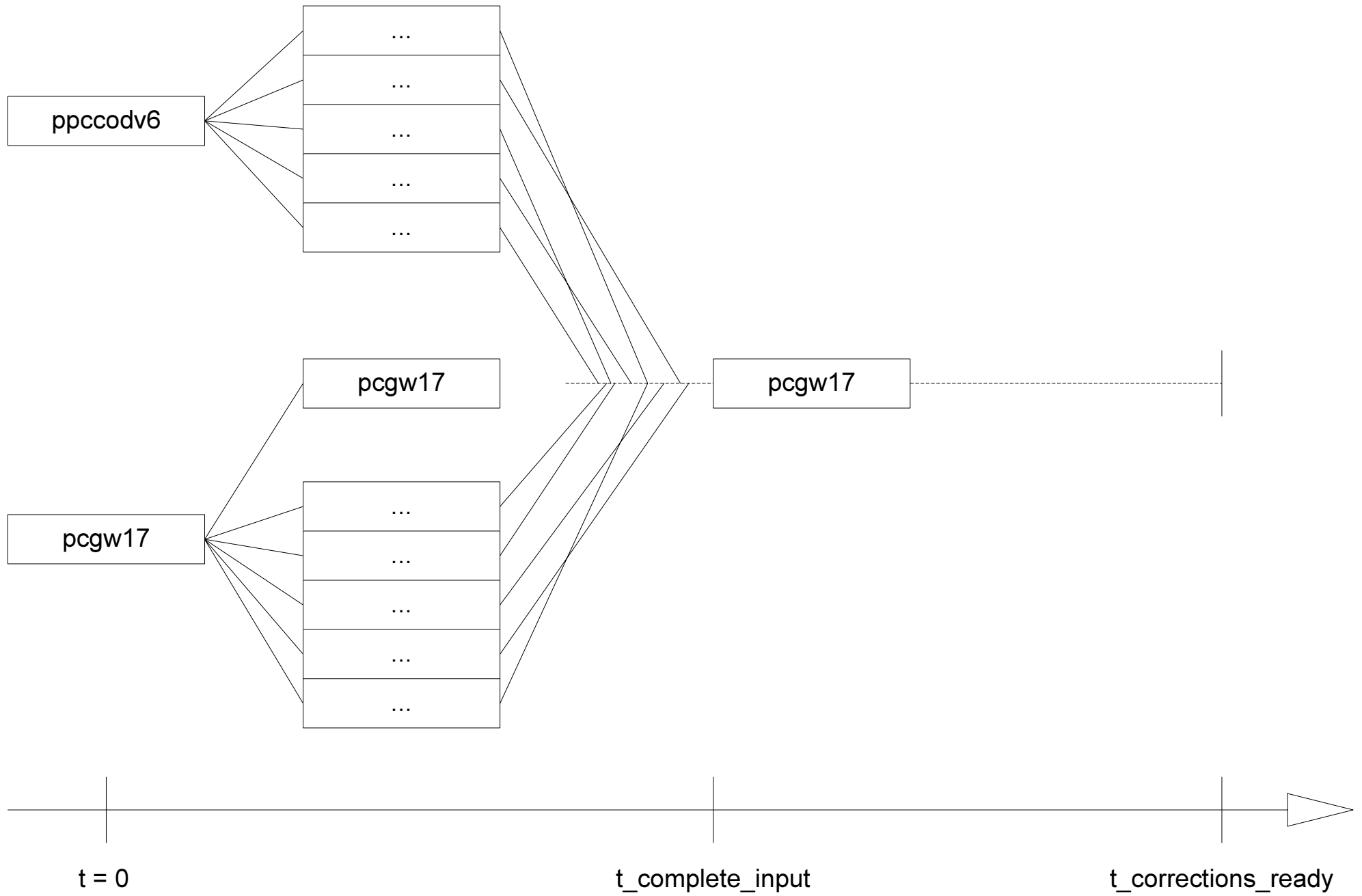

1M cycles; complete input, ready for output

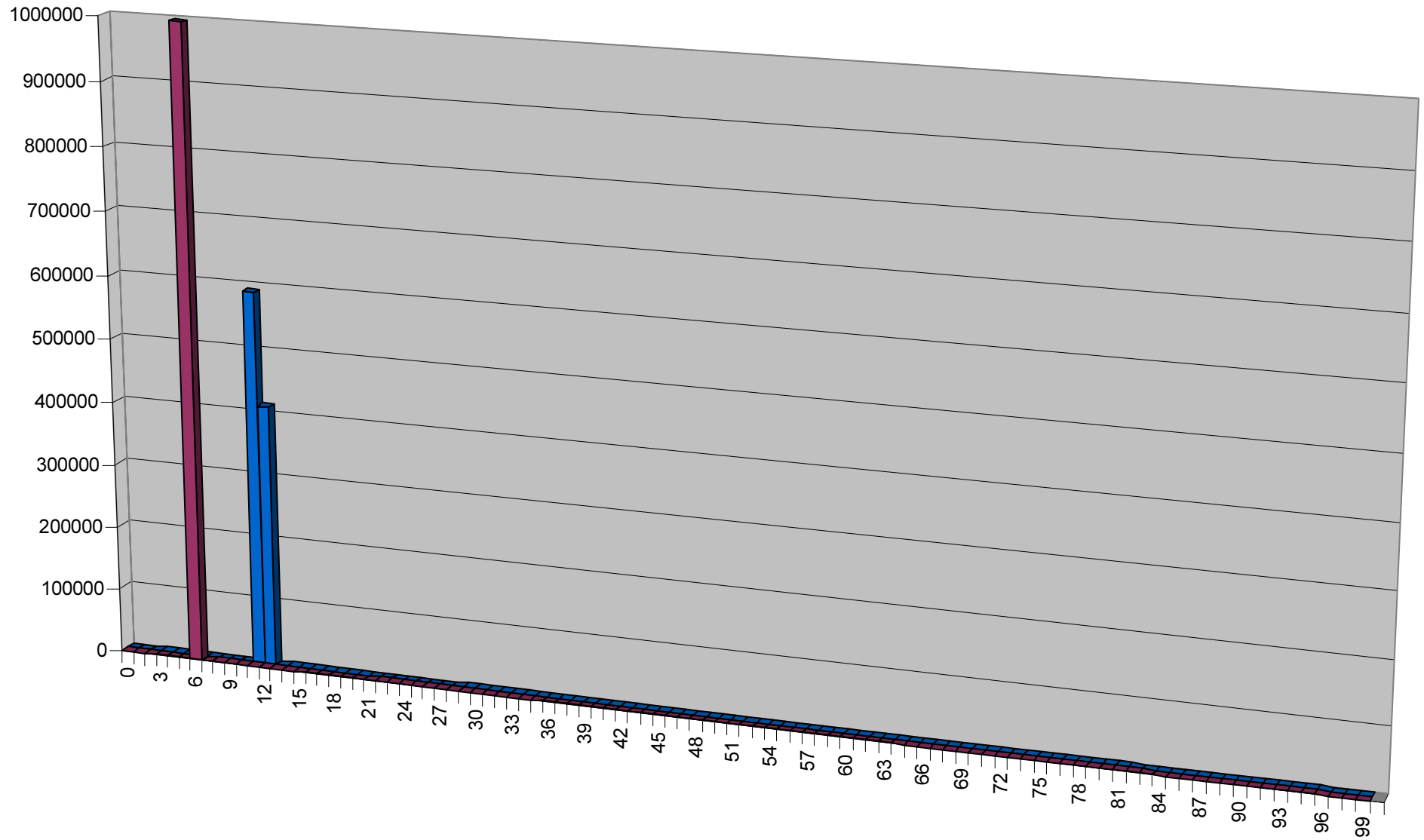

1M cycles; complete input, ready for output

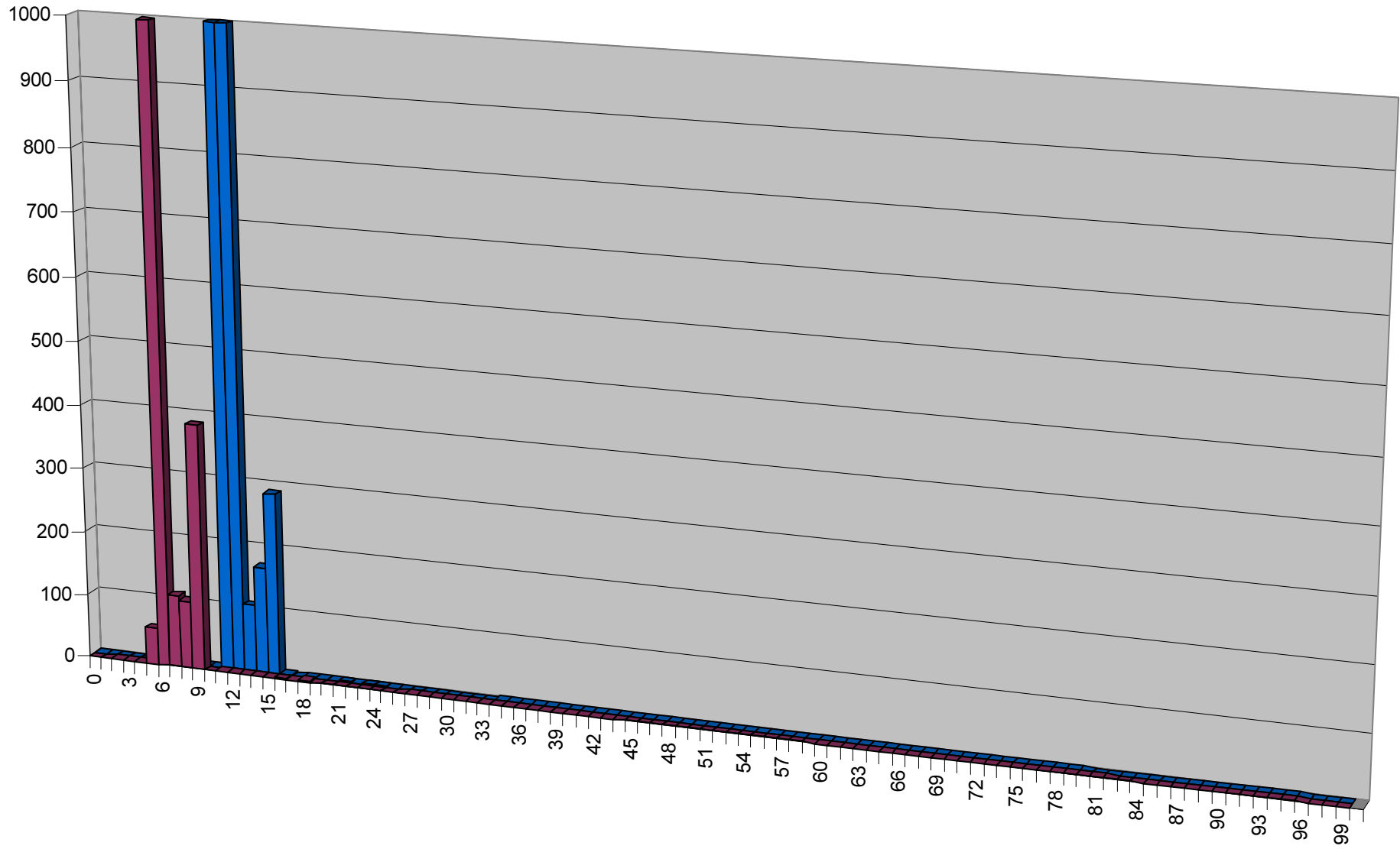

1M cycles; complete input, ready for output

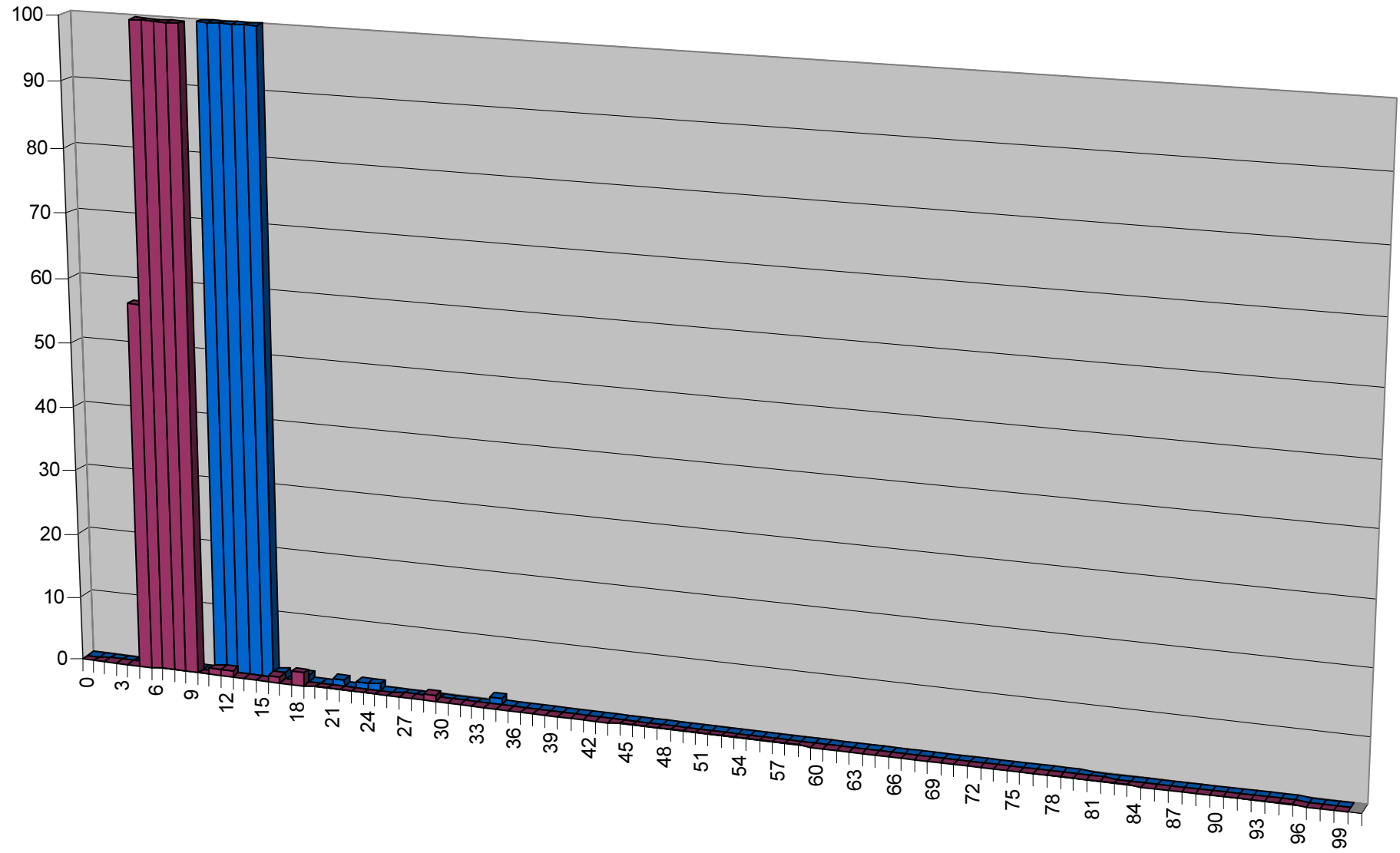

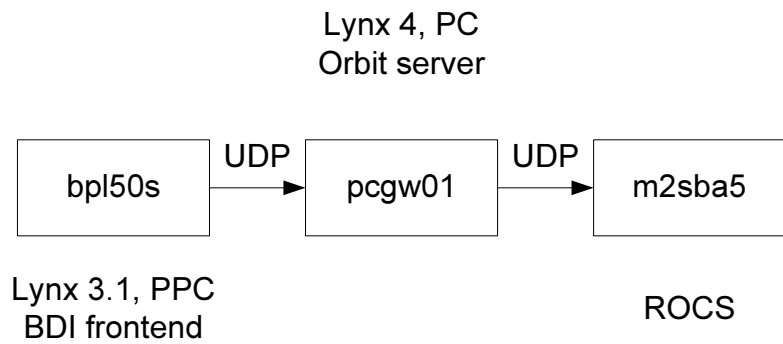

### SPS

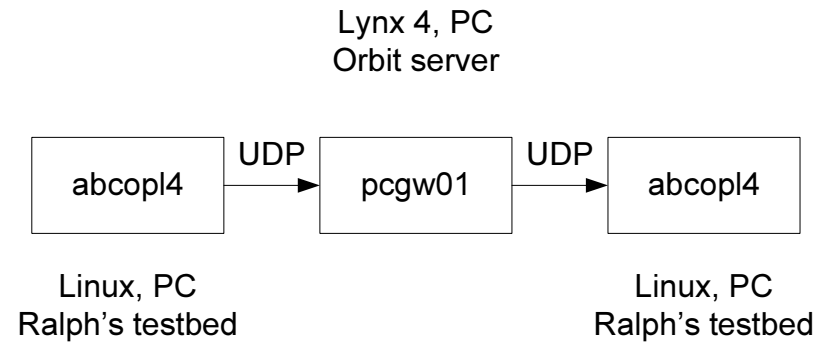

### Simulation

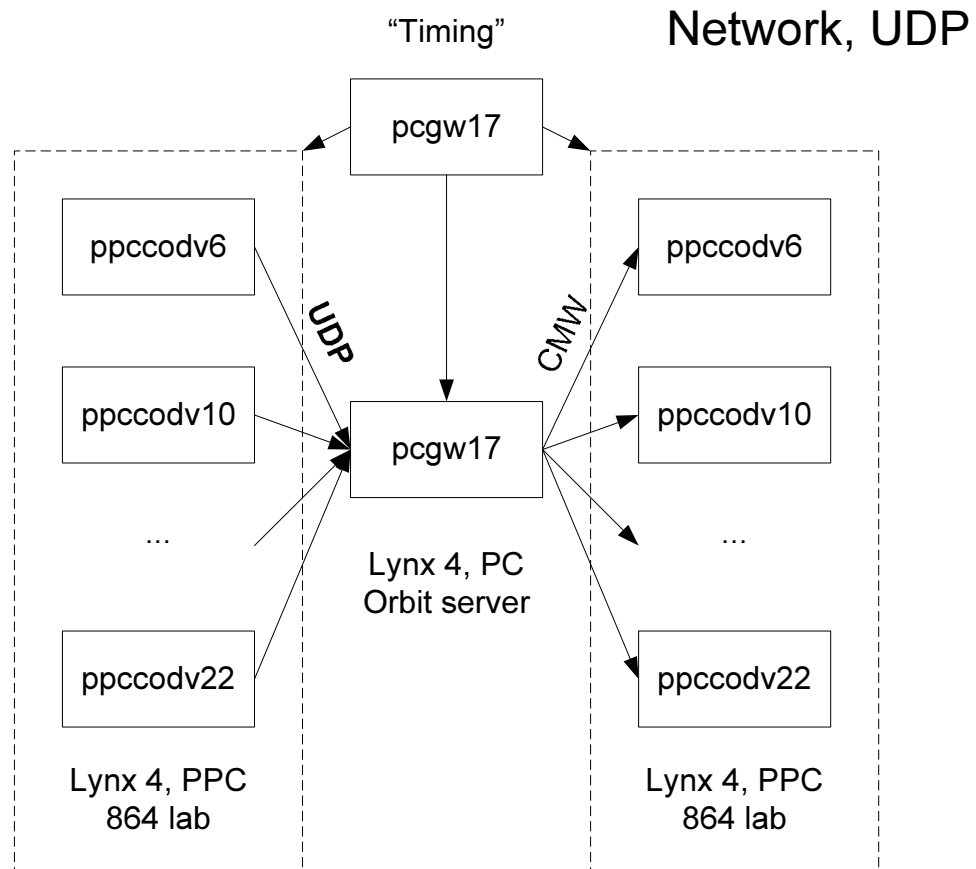

### Network, CMW

